

N 1400 SERIES PROCESS VACUUM PUMPS AND COMPRESSORS



N 1400.1.2 SP.9 E

ADVANTAGES

- Twofold safety: The combination of a working diaphragm and an additional safety diaphragm prevents gas from escaping in the event of a fracture (.12)
- The robust design will hold up to challenging operating conditions
- High pressure up to 6 bar rel./87 psig
- High level of gas tightness
Following leakage rates are available:
.9 \triangleq $< 6 \times 10^{-3}$ mbar l/s
SP.13 \triangleq $< 6 \times 10^{-6}$ mbar l/s
ST.13 \triangleq $< 6 \times 10^{-5}$ mbar l/s
SP.12 \triangleq $< 6 \times 10^{-6}$ mbar l/s

POSSIBLE AREAS OF USE

- Energy technology – especially in nuclear facilities
- Chemical industry
- Process industry
- Research and development

Please visit our website
www.knf.com
to get more information

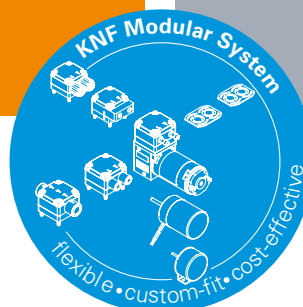

PERFORMANCE DATA					
Series model	N 1400.1.2				
Material design	SP.9 E	SP.13 E	ST.9 E	ST.13 E	SP.12 E
Pump head	Stainless steel				
Diaphragm	EPDM		PTFE-coated		EPDM
Valves	Stainless steel				
Flow rate at atm. pressure (l/min)	250.0 \pm 10 %		240.0 \pm 10 %		250.0 \pm 10 %
Ultimate vacuum (mbar abs.)	150				
Max. operating pressure (bar rel./psig)	6.0/87.0				3.0/43.5
Permissible ambient temperature (°C)	+5 ... +40				
Permissible media temperature (°C)	+5 ... +40				
Level of gas tightness (mbar x l/s)	6×10^{-3}	6×10^{-6}	6×10^{-3}	6×10^{-5}	6×10^{-6}
Weight (kg/lbs)	76.5/168.7				82.0/180.8
ELECTRICAL DATA					
Voltage (V)	230/400	200/346			230/400
Motor	Three-phase motor				
Protection class motor	IP 55				
Protection class pump	IP 00				
Frequency (Hz)	50	50/60			50
Power P ₁ (W)	1850	1500			1350
Operating current (A)	8.50/4.90	14/8.1			6.75/3.90

N 1400.1.2 SP.9 E | SP.13 E | ST.9 E | ST.13 E

PERFORMANCE DATA

Series model	Flow rate at atm. pressure (l/min)	Max. operating pressure (bar rel./psig)	Ultimate vacuum (mbar abs.)
N 1400.1.2 SP.9 E	250.0 ± 10 %	6.0/87.0	150
N 1400.1.2 SP.13 E	250.0 ± 10 %	6.0/87.0	150
N 1400.1.2 ST.9 E	240.0 ± 10 %	6.0/87.0	150
N 1400.1.2 ST.13 E	240.0 ± 10 %	6.0/87.0	150

Flow rate determined at 20 °C, 1013 mbar abs.
(Pressure 0 to 1013 mbar abs. in accordance with ISO 21360-1/2)

N 1400.1.2 S_9 E | S_13 E

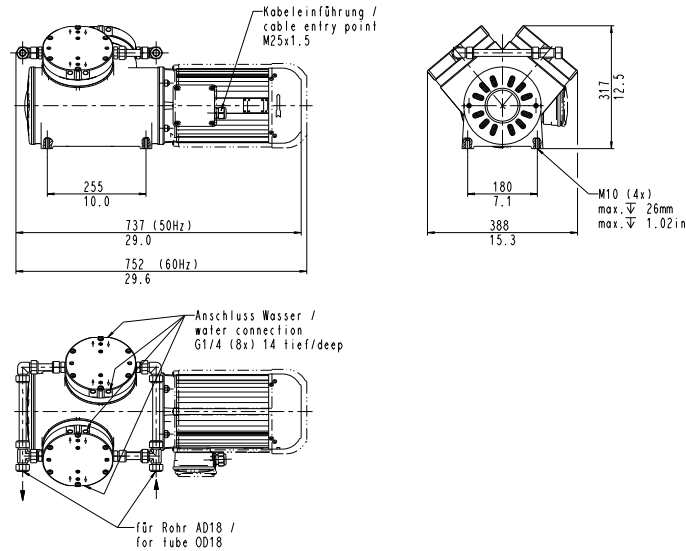

N 1400.1.2 SP.9 E | SP.13 E

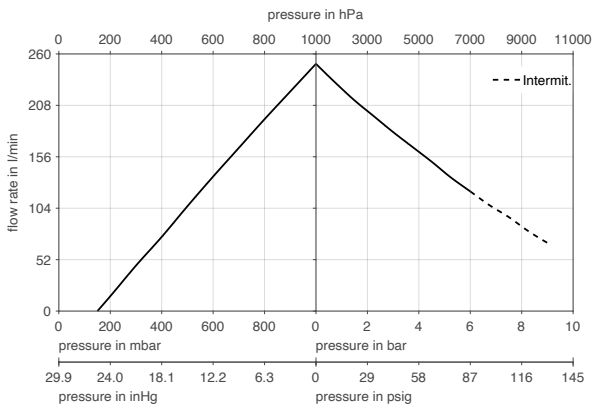

Flow rate determined at 20 °C, 1013 mbar abs.
(Pressure 0 to 1013 mbar abs. in accordance with ISO 21360-1/2)

N 1400.1.2 ST.9 E | ST.13 E

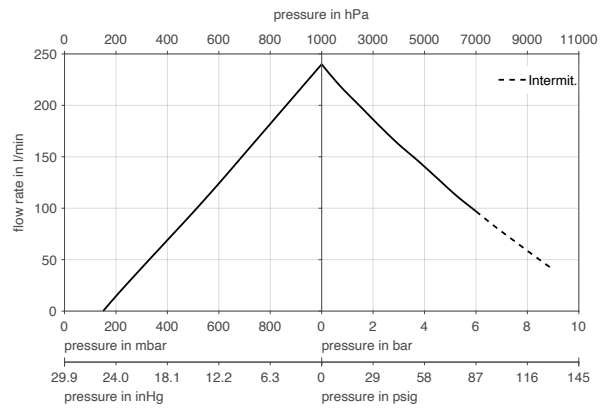

Flow rate determined at 20 °C, 1013 mbar abs.
(Pressure 0 to 1013 mbar abs. in accordance with ISO 21360-1/2)

N 1400.1.2 S_9 E | S_13 E | PUMP UP TIME FOR 20 LITER VESSEL

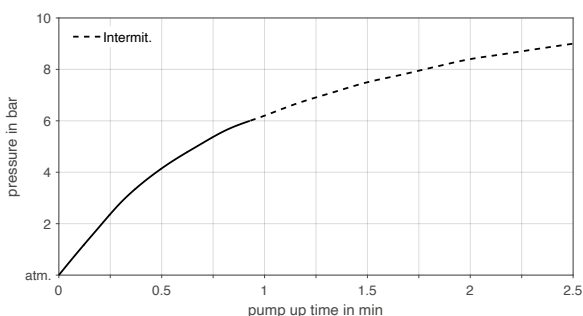

N 1400.1.2 SP.12 E

PERFORMANCE DATA

Series model	Flow rate at atm. pressure (l/min)	Max. operating pressure (bar rel./psig)	Ultimate vacuum (mbar abs.)
N 1400.1.2 SP.12 E	250.0 ± 10 %	3.0/43.5	150

Flow rate determined at 20 °C, 1013 mbar abs.

(Pressure 0 to 1013 mbar abs. in accordance with ISO 21360-1/2)

N 1400.1.2 SP.12 E

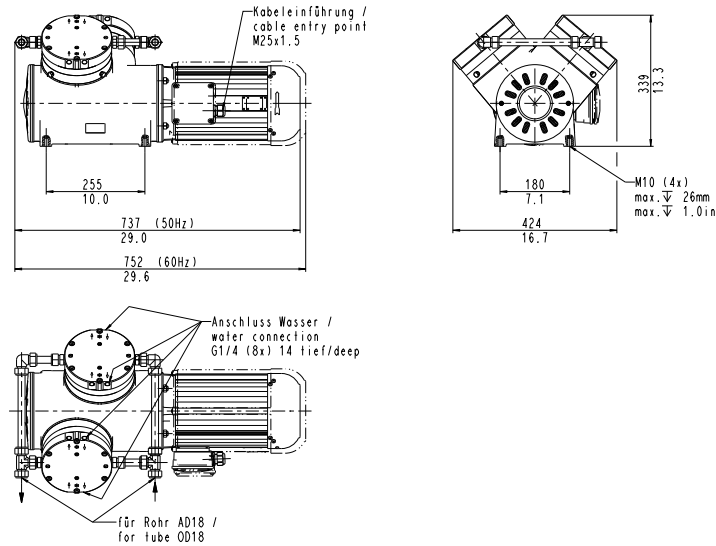

N 1400.1.2 SP.12 E

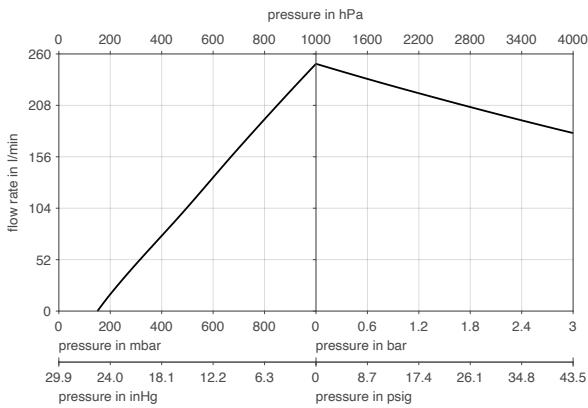



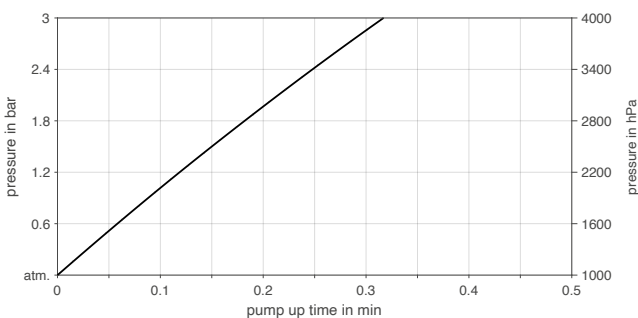

Flow rate determined at 20 °C, 1013 mbar abs.

(Pressure 0 to 1013 mbar abs. in accordance with ISO 21360-1/2)

N 1400.1.2 SP.12 E | PUMP UP TIME FOR 20 LITER VESSEL



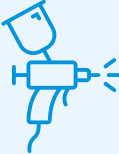



OPTIONS

Description	Illustration	Details
Mechanical adjustment of pumping capacity	 <p>A circular gauge with a needle pointing to the right, labeled 'FLOW' below it.</p>	The pumping capacity can be adjusted at the factory to accommodate inlet pressure and for accurate alignment with the customer's system.
Versions for special gases	 <p>A blue rectangular box with the text 'CORROSION RESISTANT' inside.</p>	Adjustment of the pump head for use with highly corrosive gases. Options include Hastelloy pump head components or a coating.
Cleaned contact material parts	 <p>An illustration of a pump head component with a starburst effect, indicating a cleaning or certification process.</p>	For the use of the pump with gases with high oxygen concentrations the parts that come into contact with the medium can be cleaned using a certified process.
Special coating	 <p>An illustration of a spray gun, representing a coating process.</p>	Special coatings for high corrosion protection (C4) for use in industrial areas and coastal areas with moderate salinity, such as maritime applications.
Certified head components	 <p>An illustration of a pump head component next to a document with a checkmark, representing certification.</p>	The components that come into contact with the medium are available with material certificates.
Ex-proof pumps	 <p>A globe next to a yellow hexagonal sign with a black border and the text 'Ex' inside, representing explosion-proof certification.</p>	Pumps for explosion-proof areas are available with the following certificates on request: IEC Ex, NEC Ex, KOSHA, PESO, NEPSI, JIS.

ACCESSORIES

Description	Illustration	Part No.
Base plate with rubber-bonded metals		304476
Connection water cooling S_.9 S_.13		305444
Connection water cooling SP.12		305445
Wrench for retainer plate		128753
Inlet filter G1/2		316662

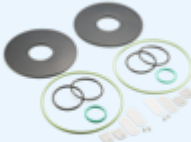
SPARE PARTS

Description	Illustration	Part No.	Details
Spare parts kit N 1400.1.2 SP.9 E		315482	Spare parts kit consists of: 2x diaphragms, 4x reed valves, 4x valve stoppers, 4x O-rings, 4x screws. This set is required to maintain the pump.
Spare parts kit N 1400.1.2 SP.13 E		313336	Spare parts kit consists of: 2x diaphragms, 4x reed valves, 4x valve stoppers, 8x O-rings, 4x screws. This set is required to maintain the pump.
Spare parts kit N 1400.1.2 ST.9 E		315484	Spare parts kit consists of: 2x diaphragms, 4x reed valves, 4x valve stoppers, 4x O-rings, 4x screws. This set is required to maintain the pump.
Spare parts kit N 1400.1.2 ST.13 E		315485	Spare parts kit consists of: 2x diaphragms, 4x reed valves, 4x valve stoppers, 8x O-rings, 4x screws. This set is required to maintain the pump.
Spare parts kit N 1400.1.2 SP.12 E		315483	Spare parts kit consists of: 4x diaphragms, 4x reed valves, 4x valve stoppers, 16x O-rings, 6x screws, 2x serrated washer. This set is required to maintain the pump.

The performance values for the series models shown on this data sheet were determined under test conditions. The actual performance values may differ and depend in particular on the usage conditions and therefore on the specific application, on the parameters of the components involved in the user's system and on any technical modifications carried out which deviate from the standard configuration or the as delivered condition.

If individual designs have been created for specific customers on the basis of series models, other technical performance data may apply. Before operation begins, the relevant operating instructions and/or assembly or installation instructions should be read and the safety information contained in these instructions should be noted. KNF reserves the right to make changes to the product and the associated documentation without prior notice to the customer.



www.knf.com